

1 Battery Bank - Part: U3/MER/DC-CAB2-1

16 Way Molex
(Connector 2)

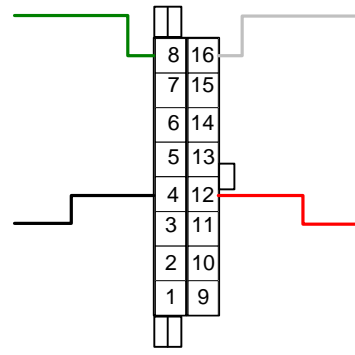

Connector 2 Pin Connections	
1.	Unused
2.	Unused
3.	Unused
4.	B1 Black
5.	Unused
6.	Unused
7.	Unused
8.	B1 Green
9.	Unused
10.	Unused
11.	Unused
12.	B1 Red
13.	Unused
14.	Unused
15.	Unused
16.	B1 White

Heatshrink
(Cut 50mm)

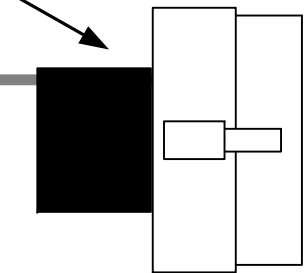

Notes:

1. Cable Cut Length 1500mm
2. Coloured Heat Shrink added to Twisted Pair Cable for Battery ID

1 x (2 Pair) Twisted Pair Cable

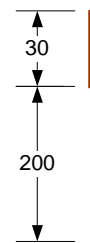

Shunt & Temp Sense Loom
Brown Ident - Battery 1

B1

2 Battery Bank - Part: U3/MER/DC-CAB2-2

16 Way Molex
(Connector 2)

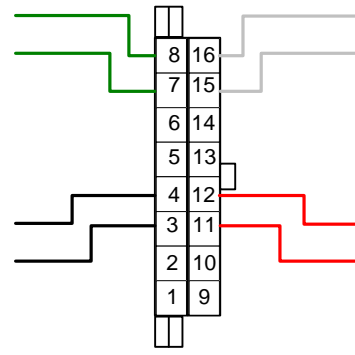

Connector 2 Pin Connections	
1.	Unused
2.	Unused
3.	B2 Black
4.	B1 Black
5.	Unused
6.	Unused
7.	B2 Green
8.	B1 Green
9.	Unused
10.	Unused
11.	B2 Red
12.	B1 Red
13.	Unused
14.	Unused
15.	B2 White
16.	B1 White

Heatshrink
(Cut 50mm)

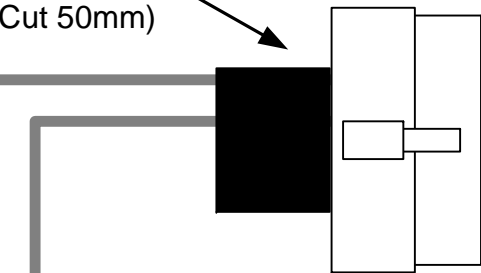

Notes:

1. Cable Cut Length 1500mm
2. Coloured Heat Shrink added to Twisted Pair Cable for Battery ID

2 x (2 Pair) Twisted Pair Cable

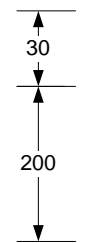

Shunt & Temp Sense Loom
Brown Ident - Battery 1
Red Ident - Battery 2

B1 B2

3 Battery Bank - Part: U3/MER/DC-CAB2-3

16 Way Molex
(Connector 2)

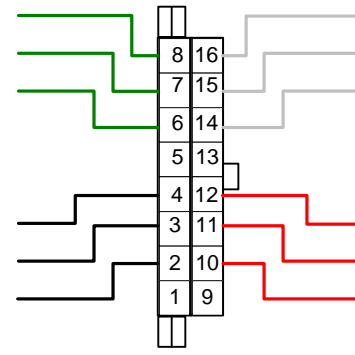

Connector 2 Pin Connections	
1.	Unused
2.	B3 Black
3.	B2 Black
4.	B1 Black
5.	Unused
6.	B3 Green
7.	B2 Green
8.	B1 Green
9.	Unused
10.	B3 Red
11.	B2 Red
12.	B1 Red
13.	Unused
14.	B3 White
15.	B2 White
16.	B1 White

Heatshrink
(Cut 50mm)

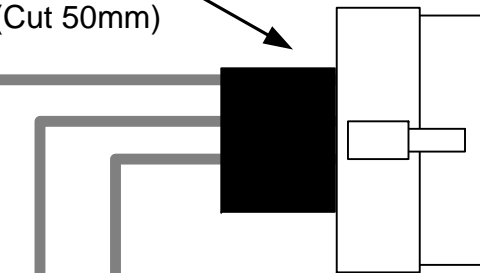

Notes:

1. Cable Cut Length 1500mm
2. Coloured Heat Shrink added to Twisted Pair Cable for Battery ID

3 x (2 Pair) Twisted Pair Cable

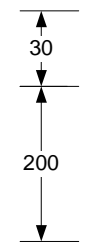

Shunt & Temp Sense Loom
Brown Ident - Battery 1
Red Ident - Battery 2
Blue Ident - Battery 3

B1 B2 B3

4 Battery Bank - Part: U3/MER/DC-CAB2-4

16 Way Molex
(Connector 2)

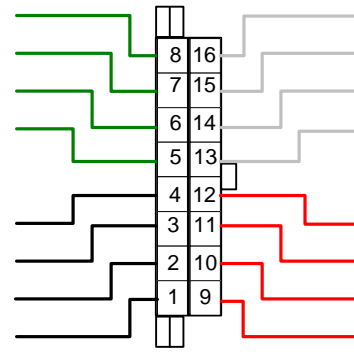

Connector 2 Pin Connections	
1.	B4 Black
2.	B3 Black
3.	B2 Black
4.	B1 Black
5.	B4 Green
6.	B3 Green
7.	B2 Green
8.	B1 Green
9.	B4 Red
10.	B3 Red
11.	B2 Red
12.	B1 Red
13.	B4 White
14.	B3 White
15.	B2 White
16.	B1 White

Heatshrink
(Cut 50mm)

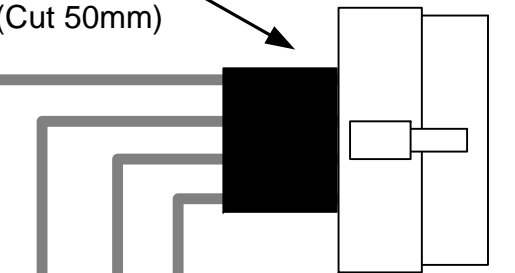

Notes:

1. Cable Cut Length 1500mm
2. Coloured Heat Shrink added to Twisted Pair Cable for Battery ID

4 x (2 Pair) Twisted Pair Cable

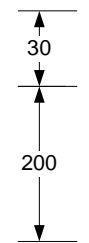

Shunt & Temp Sense Loom
Brown Ident - Battery 1
Red Ident - Battery 2
Blue Ident - Battery 3
No Ident - Battery 4

B1 B2 B3 B4

Cable	Eland 2 x Twisted Pair - Part No: 8723LSF
Connector	Molex 16 Way - Part No: 39-01-2160
Pins	Molex Contact 18-24awg - Part No: 39-00-0039
Black Heatshrink	Adhesive Lined (Size To Fit)
Brown Heatshrink	6.4mm Dia
Red Heatshrink	6.4mm Dia
Blue Heatshrink	6.4mm Dia

TITLE	DRAWN	DIMENSIONS IN mm	ISSUE	DATE	AUTH	MODIFICATION DESCRIPTION
	Datacell II Connector 2 Cable					
CLIENT	DATE	NOTES				
	23 rd April 2013					
Merlin	CHECKED					

Merlin Equipment Ltd, Unit 4, Cabot Business Village, Holyrood Close, Cabot Lane, Poole, Dorset BH17 7BX

Tel: 01202 - 697979 Fax: 01202 - 691919
www.merlinequipment.com

© 2011 Merlin Equipment Limited. This drawing remains the sole right and property of Merlin Equipment Limited. You may not make unauthorised copies or pass this information to third parties without the express written permission of Merlin Equipment Limited.



DRAWING No.

624